



US 20050070197A1

(19) **United States**

(12) **Patent Application Publication** (10) **Pub. No.: US 2005/0070197 A1**
Benson (43) **Pub. Date: Mar. 31, 2005**

(54) **FLYABLE BALL**

Publication Classification

(76) **Inventor: Donald M. Benson, Grant, MI (US)**

(51) **Int. Cl.⁷** **A63H 27/00**
(52) **U.S. Cl.** **446/34**

Correspondence Address:
DONALD M. BENSON
3433 EAST 100TH STREET
GRANT, MI 49327 (US)

(57) **ABSTRACT**

The flyable ball has a unitary spherically shaped body made from a resilient material, with the body having a center axis and a transverse center axis. The body further includes a radially outward extending ring or rim projecting from the body and located below the transverse center axis for supplying centrifugal stabilization to the body when the ball is thrown into the air with a spin.

(21) **Appl. No.: 10/672,471**

(22) **Filed: Sep. 26, 2003**

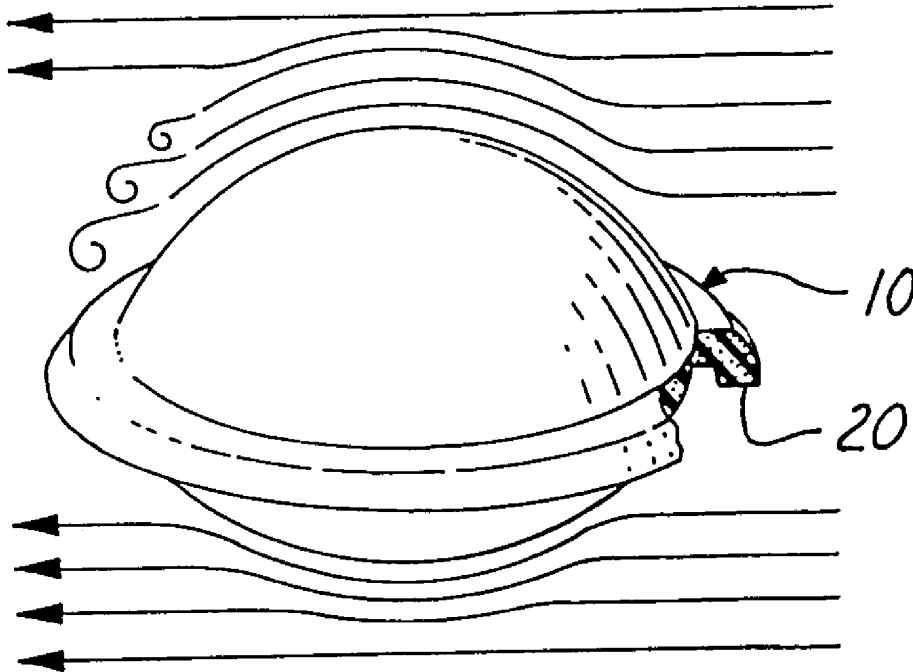

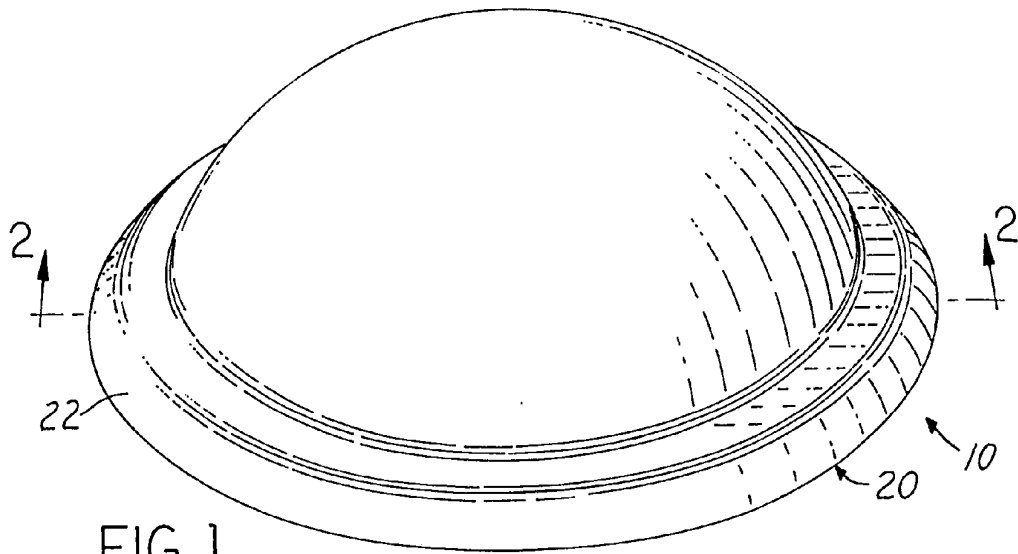

FIG. 1

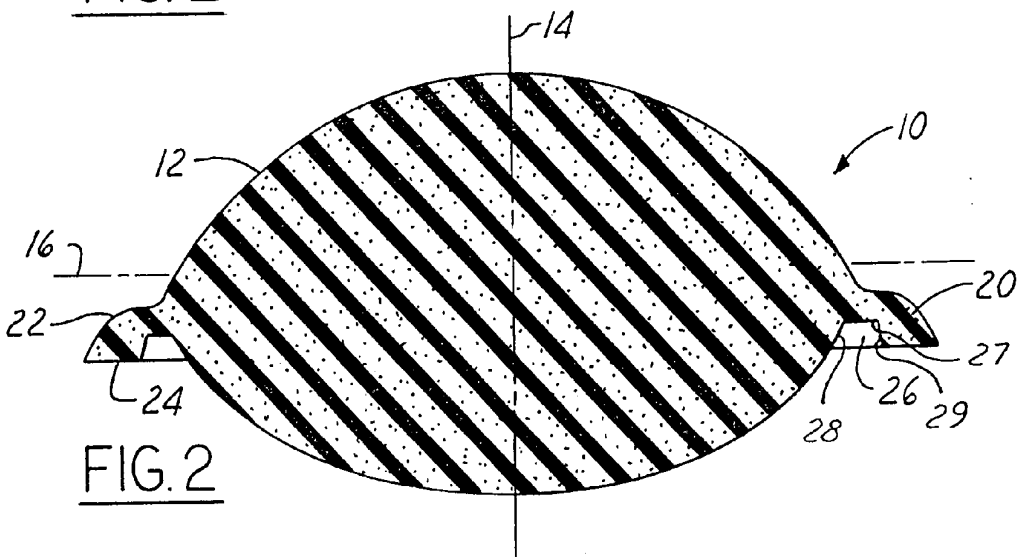

FIG. 2

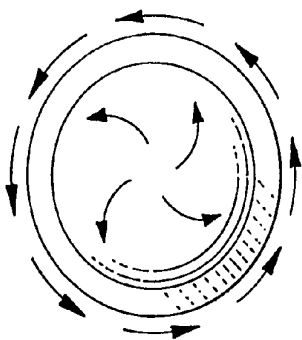

FIG. 3

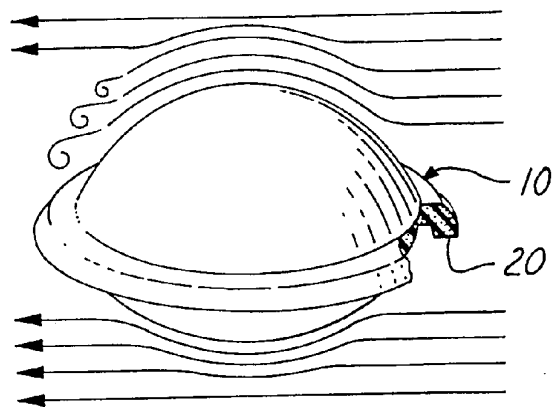

FIG. 4

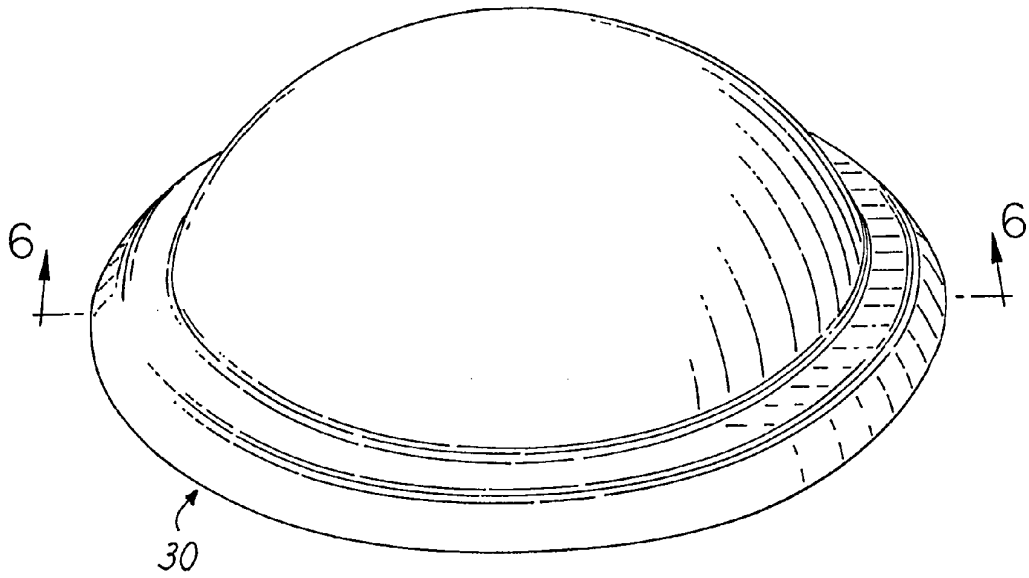

FIG. 5

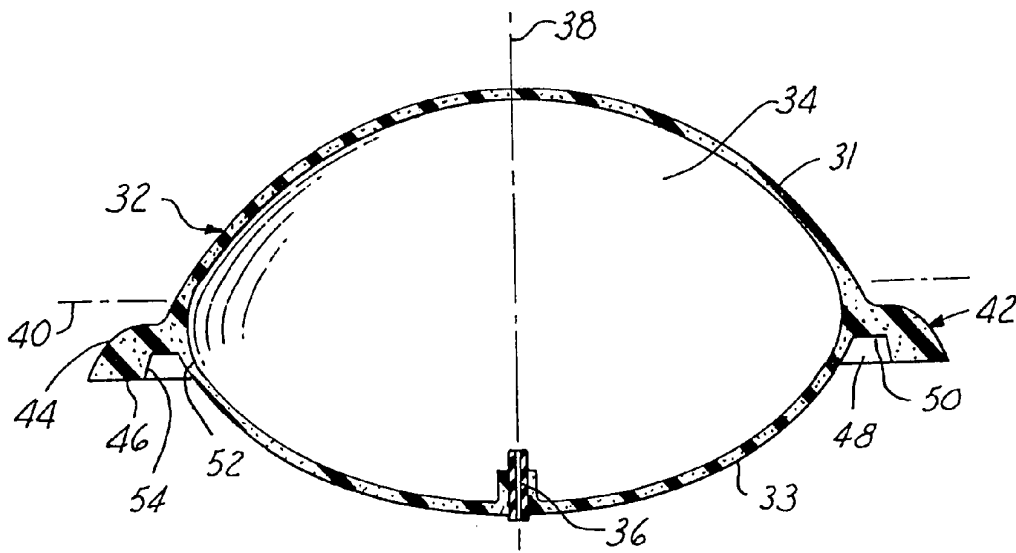

FIG. 6

FLYABLE BALL

BACKGROUND OF THE PRESENT INVENTION

[0001] 1. Field of the Invention

[0002] The present invention relates to an object such as a toy or ball which, when rotated or spun through the air, utilizes centrifugal force and gyroscopic and aerodynamic principles to fly through the air. The object is held and thrown into the air in much the same manner as a Frisbee disk.

[0003] 2. Brief Description of the Prior Art

[0004] The flight of the Frisbee disk has been known for many years. It consists of a unitary, generally circular plastic body in the shape of a plate or pie tin or of similar configuration which forms a wing and when spun in the air, stays aloft due to aerodynamic lift and gyroscopic stability. Forward flight splits rushing air at the leading edge of the airborne disk. Half of the air goes over the top of the disk and the other half of the air goes underneath the disk. Because the edge of the disk is tipped up, the disk deflects the lower airstream downward. As the disk pushes down on the air, the air pushes upward on the disk resulting in a force known as the aerodynamic lift. The upper airstream is also deflected downward like all viscous fluids, since flowing air tends to follow curved surfaces even when those surfaces bend away from the airstream. The inward bend of the upper airstream is accompanied by a substantial drop in air pressure just above the disk thereby sucking the disk upward.

[0005] The prior art further includes the following U.S. patents: U.S. Pat. No. 3,758,985 issued on Sep. 18, 1973 to Heisler entitled "Discus Toy"; U.S. Pat. No. 4,262,911 issued on Apr. 21, 1981 to Opresik et al entitled "Martian Flyer or Earth U.F.O."; U.S. Pat. No. 4,335,536 issued Jun. 22, 1982 to Magid et al entitled "Inflatable Throwing Toy"; U.S. Pat. No. 5,045,011 issued Sep. 3, 1991 to Lovik entitled "Flying Balloon Toy"; U.S. Pat. No. 5,123,869 issued Jun. 23, 1992 to Schipmann entitled "Aerodynamic Toy"; U.S. Pat. No. 5,360,363 issued Nov. 1, 1994 to Levin entitled "Flying Disk with Rotatable Member"; U.S. Pat. No. 5,882,239 issued Mar. 16, 1999 to Trichak entitled "Illuminatable Aerodynamic Disc or Saucer"; and U.S. Pat. No. 5,984,753 issued Nov. 16, 1999 to Perez entitled "Aerodynamic Toy".

SUMMARY OF THE PRESENT INVENTION

[0006] A feature of the present invention relates to a flyable ball comprising a unitary spherically shaped body made from a resilient material, with the body having a center axis, a transverse center axis and a radially outwardly extending annular ring or rim projecting from the body and located below the transverse center axis for supplying centrifugal stabilization when the ball is thrown through the air with a spin.

[0007] Another feature of the present invention is to provide a flyable ball of the aforementioned type wherein the annular rim includes a pair of surfaces which are configured and shaped to form an air foil which causes lift and guides the ball in flight after the ball is spun through the air and thrown by a person gripping the annular rim.

[0008] Still another feature of the present invention is to provide a flyable ball of the aforementioned type wherein the body has a hollow interior and is inflatable with air directed through a valve provided in the body.

[0009] A further feature of the present invention is to provide a flyable ball of the aforementioned type wherein the resilient material is vinyl plastic.

[0010] A still further feature of the present invention is to provide a flyable ball of the aforementioned type wherein the resilient material of the spherically shaped body is a chemically activated foam which fills the interior thereof.

[0011] Another feature of the present invention is to provide a flyable ball of the aforementioned type wherein the ring or rim has an annular groove in one of the surfaces which is furthest away from the transverse axis, with the air moving under the ball creating a vacuum where the air contacts the grooved rim.

[0012] Still another feature of the present invention is to provide a flyable ball of the aforementioned type wherein the surface of the annular rim closest to the transverse axis curves in a direction towards the surface provided with the annular groove.

[0013] Another feature of the present invention is to provide a toy or ball which is made by a molding process and which is simple in construction, easy to manufacture, economical to produce and efficient in operation.

BRIEF DESCRIPTION OF THE DRAWINGS

[0014] **FIG. 1** is a top perspective view of the flyable toy or ball.

[0015] **FIG. 2** is a sectional view through the center of the ball taken on the line 2-2 of **FIG. 1** and showing the solid foam interior thereof.

[0016] **FIG. 3** is a top view of the flyable ball in flight illustrating the air circulating across the top of the ball and around the rim.

[0017] **FIG. 4** is a front elevational view of the ball or toy, with a rim part broken away and in section, and illustrating the toy in rotation, with air flowing across the top and bottom of the toy resulting in an upward aerodynamic lift.

[0018] **FIG. 5** is a top perspective view of another embodiment of the flyable toy or ball.

[0019] **FIG. 6** is a cross sectional view through the ball taken on the line 6-6 of **FIG. 5** and illustrating the hollow interior thereof filled with air.

DESCRIPTION OF THE PREFERRED EMBODIMENT

[0020] The present invention discloses two embodiment of the toy, one embodiment having a solid foam interior and the other ball being inflatable, with the interior thereof occupied by air. Each embodiment is made by a molding process, with similar but different molds being used in producing each embodiment. The inflatable ball (**FIGS. 5 and 6**) is made from vinyl utilizing a conventional rotational molding process. The foam toy is made in a mold in which the chemically activated foam is injected with the foam growing after it is poured into the mold.

[0021] Referring now to **FIGS. 1 and 2**, the toy or ball is designated by the numeral **10**. It has a unitary spherically shaped body **12** made from a resilient plastic material such as a chemically activated foam now utilized in producing Nerf footballs for children.

[0022] The spherically shaped body **12** has a center axis **14** and a transverse axis **16** which intersects and is perpendicular to the center axis **14**. The body **12** is provided with a radially outwardly extending annular ring or rim **20** which is located below the transverse axis **16**. Because the ring or rim **20** is placed below the transverse axis **16**, or the center of the spherical shaped body **12**, it creates an air foil which causes lift and a gliding effect when the toy **10** is spinning and passing through the air. The configuration of the body **12** and the softness or resiliency of the material makes the toy easy and safe to catch.

[0023] The annular ring or rim **20** includes a pair of surfaces including a first surface **22** which is closest to the transverse axis **16** and a second surface **24** which lies in a plane parallel to the plane containing the axis **16**. The first surface **22** is curved away from the body **12** and towards the second surface **24** where it intersects same at the outer edge of the ring or rim **20**. The ring **20** is provided with an annular open groove **26** in the bottom surface **24**. The annular open groove **26** has a flat annular surface **27** and a pair of side surfaces **28** and **29**. The groove **26** is spaced inwardly from the edge of the ring where the first and second surfaces **22** and **24** intersect.

[0024] It should be noted that the upper portion of the spherical shaped body **12** is larger than the lower portion as viewed in **FIG. 2**. The toy **10** has an outside rim diameter at the edge of the rim of approximately $8\frac{1}{8}$ inches. The height of the toy **10** measured along the center axis **14** is approximately $3\frac{1}{2}$ inches. It will be appreciated that the ball or toy **10** will be made in various sizes using generally the same shape and configuration.

[0025] In use, a person standing and throwing this object initially grips the rim **20** and spins the object, either overhand or underhand, backhand or forehand on a horizontal axis which will allow gyroscopic and aerodynamic principles to take effect, thus creating a gliding flight for the ball **10**. The ball **10** can also be thrown underhand or overhand on a vertical axis and bounced or rolled across the ground.

[0026] When the object or ball **10** is held by the rim and thrown in much the same manner as a person would a Frisbee disk, the air, as shown in **FIG. 4**, travels a greater distance over the top of the ball **10** than below the ball **10**. The air moving over the ball **10** creates a vacuum where the ball meets the lip or rim **20**, thereby aiding in achieving flight. The centrifugal force illustrated in **FIG. 3** by the series of arrows creates a gyroscopic stabilization which enables the ball **10** to remain stable in flight when thrown with the spin thereby allowing the aerodynamic principles to take effect.

[0027] The other embodiment is illustrated in **FIGS. 5 and 6** and it discloses an inflatable ball or toy **30** having the same overall appearance as the foam ball illustrated in **FIGS. 1 and 2**. The spherically shaped ball **30** is made in a rotational molding process utilizing vinyl plastic material which forms the spherically shaped body **32**. The interior of the body **32** is hollow and a valve **36** is provided in the lower

portion of the body **32** to permit air to be directed into the interior of **34** much like an inflatable football or basketball. The body **32** has a center axis **38** and a transverse axis **40**. The body **32** has an upper portion **31** and a lower portion **33** and further includes a radially outwardly extending annular rim or ring **42** which is located below the transverse center axis **40** as illustrated in **FIG. 6**. The rim or ring **42** has a pair of first and second surfaces **44** and **46**. The first surface **44** is curved away from the body **32** and towards the second surface **46** where it intersects surface **46** at the outer edge of the rim **42**. The second surface **46** is provided with an annular open groove **48** which has a flat annular surface **50** and a pair of side surfaces **52** and **54**. The upper portion of the body **32** above the ring or rim **42** is larger in area than the lower portion of the body **32** located below the ring or rim **42**. The ring **42** forms an air foil which causes lift and a gliding effect when the ball is spun and is in flight. As with the first embodiment, the configuration of the ball and the softness makes it easy to catch. A person standing and throwing the ball **30** with a spin, either overhand or underhand, backhand or forehand on a horizontal axis allows well known gyroscopic and aerodynamic principles to come into play thus creating a gliding flight for the ball **30**. Because the air travels a greater distance across the top of the ball, an aerodynamic lift is created. Air moving under the ball creates a vacuum where the ball meets the grooved rim **42**. This also aids in achieving flight.

1. A flyable ball comprising a spherically shaped body having a center axis and a transverse center axis;

a radially outwardly extending annular rim projecting outwardly from and being integral with said body and located below and spaced from said transverse axis;

said body and said rim being formed unitarily in a mold from a chemically activated foam which fills the mold to provide a smooth outer surface on said body and said rim, with the interior of said body and said rim being completely and entirely filled with foam;

said body having upper and lower portions;

the upper portion of said spherically shaped body above said annular rim being larger in area than the lower portion of said body below said annular rim;

spherical sectors with the lower portion having a larger diameter than the upper portion and are equal at the point of the intersection;

said annular rim including a pair of first and second intersecting surfaces which are configured and shaped to form an air-foil which causes lift and guides the ball in flight after the ball is spun in the air by a person gripping said annular rim;

said second surface which is furthest away from said transverse center axis being straight and parallel to said transverse axis and having an annular open groove provided therein throughout the circumferential extent of said annular rim;

said annular open groove having a flat annular surface and a pair of side surfaces;

said first surface which is directly opposite to said transverse axis curving outwardly and downwardly from said upper portion and intersecting said second surface;

said annular open groove being located and spaced inwardly from the edge of said annular rim where said first and second surfaces intersect;

said annular rim providing a hand grip for a person to grip said body and to rotate said body and said rim in the air resulting in the air rushing across the upper and lower portions of said body and said rim causing the air

beneath said body to exert an upwardly force on said lower portion thereby creating an aerodynamic lift, with the air moving across the upper portion of said body resulting in a substantial drop in air pressure above said body.

* * * * *